



## Ultra-Fast Soft Recovery Diode Module

### Description

Ultra-FRD module devices are optimized to reduce losses and EMI/RFI in high frequency power conditioning electrical systems. These diode modules are ideally suited for power converters, motors drives and other applications where switching losses are significant portion of the total losses.

### Features

- ☞ Repetitive Reverse Voltage :  $V_{RRM} = 100V$
- ☞ Low Forward Voltage Drop :  $V_F(\text{typ.}) = 0.80V$
- ☞ Average Forward Current :  $I_F(\text{AV.}) = 600A$  @  $T_c = 100^\circ C$
- ☞ Ultra-Fast Reverse Recovery Time :  $t_{rr}(\text{typ.}) = 80\text{ ns}$
- ☞ Extensive Characterization of Recovery Parameters
- ☞ Reduced EMI and RFI
- ☞ Non Isolation Type Package

### Applications

Motor Drives, Free wheel use, High Power Converters, Welders, Various Switching and Telecommunication Power Supply.

### Equivalent Circuit and Package

Equivalent Circuit

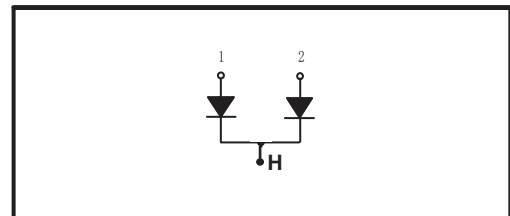

Package

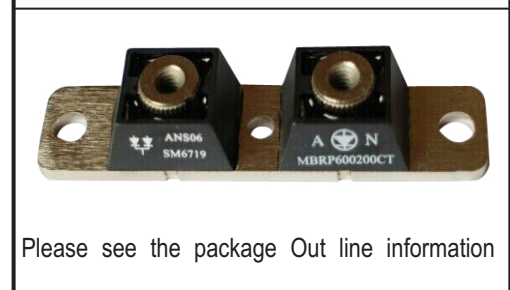

Please see the package Out line information

### Absolute Maximum Ratings @ $T_j = 25^\circ C$ (Per Leg)

Symbol	Parameter	Conditions	Ratings	Unit
$V_{RRM}$	Repetitive Peak Reverse Voltage		100	V
$V_R(\text{DC})$	Reverse DC Voltage		100	V
$I_F(\text{AV})$	Average Forward Current	Resistive Load	600 600	A A
$I_{FSM}$	Surge (non-repetitive) Forward Current	One Half Cycle at 60Hz, Peak Value	4000	A
$I^2_t$	$I^2t$ for Fusing	Value for One Cycle Current, $t_w = 8.3\text{ms}$ , $T_j = 25^\circ C$ Start	$119 \times 10^3$	$A^2s$
$T_j$	Junction Temperature		$-40 \sim 125$	$^\circ C$
$T_{stg}$	Storage Temperature		$-40 \sim 125$	$^\circ C$
$P_d$	Maximum Power Dissipation		1160	W
-	Mounting Torque		4.0	N.m
-	Terminal Torque		3.0	N.m



# 缙云县晶泰电子有限公司

Jinyun County Jing Tai Electronics Co., Ltd.

MBRP600100CT

## Thermal Characteristics

Symbol	Parameter	Conditions	Values			Unit
			Min.	Typ.	Max.	
$R_{th(j-c)}$	Thermal Resistance	Junction to Case	-	-	0.10	$^{\circ}C/W$

## Electrical Characteristics@ $T_j=25^{\circ}C$ (unless otherwise specified)

Symbol	Parameter	Conditions	Values			Unit	
			Min.	Typ.	Max.		
$V_R$	Cathode Anode Breakdown Voltage	$I_R = 100\mu A$	100	-	-	V	
$V_{FM}$	Maximum Forward Voltage	$I_{FM} = 600A, T_c = 25^{\circ}C$	-	0.87	0.84	V	
		$I_{FM} = 600A, T_c = 100^{\circ}C$	-	0.81	0.8	V	
$I_{RRM}$	Repetitive Peak Reverse Current	$T_c = 100^{\circ}C, V_{RRM}$ applied	-	-	10.0	mA	
$t_{rr}$	Reverse Recovery Time	$I_{FM} = 600A,$ $V_R = 100V$ $di/dt = -100A/\mu s$	$T_c = 25^{\circ}C$	-	80	100	ns
			$T_c = 100^{\circ}C$	-	150	-	ns

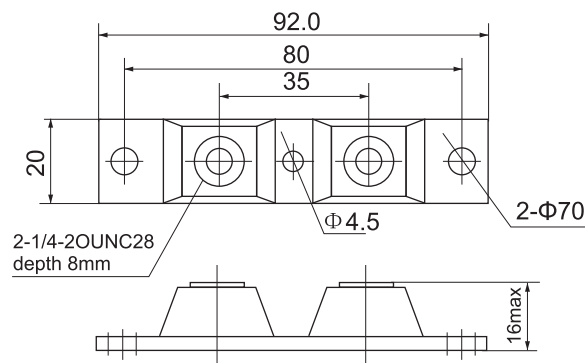



## Performance Curves

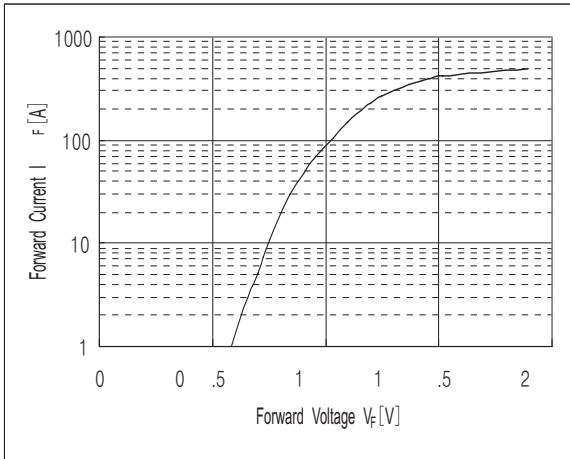

Fig. 1 : Typical Forward Voltage Drop vs. Instantaneous Forward Current

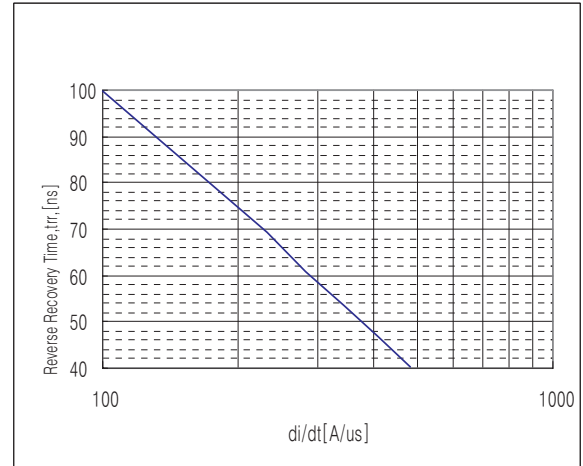

Fig. 2 : Typical Reverse Recovery Time vs.  $-di/dt$

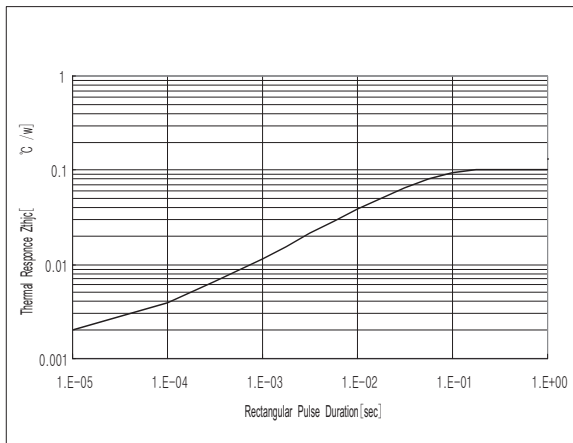

Fig. 3 : Transient Thermal Impedance ( $Z_{thjc}$ ) Characteristics

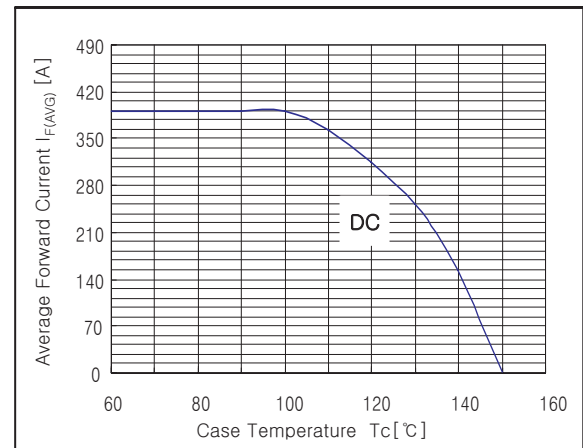

Fig. 4 : Forward Current Derating Curve